



**Phone: (765)448-4800**

**FAX: (765) 448-4885**

**Parts Tech. Hotline: 1-800-542-3088**

# **Flat Multi-Hole Tab Chart**

**Tabs sorted by Shape, Hole Size,  
Material, Thickness and Part  
Number**

**Click on any image to find out more information for that tab.  
(You may go online to order any of these tabs through our E-catalog.  
Make sure to connect to the internet before attempting the link below.)  
E-catalog URL - <http://secure.mckinneycorp.com>**

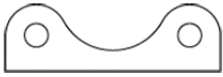

FC - 281



FC - 281 - A



FC - 509 - AT



FC - 591



M - 79



M - 121 - I



M - 187 - A



M - 188



M - 189



SPL - 118



SPL - 257



SPL - 268



SPL - 318

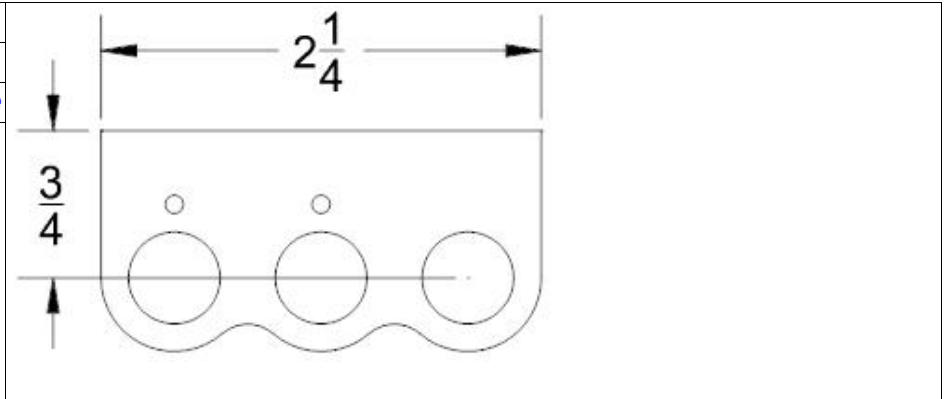

TF - 337

<b>Part #</b>	TF-337		
<b>Desc.</b>	SWITCH TAB (3-HOLE)		
<b>Material</b>	4130	<a href="#">Back to Image</a>	
<b>Hole Size A</b>	.094"		
<b>Hole Size B</b>	.469"		
<b>Hole Size C</b>			
<b>Base Width</b>	2 1/4"		
<b>Thickness</b>	.063"		
<b>Style</b>	flat multi hole		
<b>Comment</b>			

<b>Part #</b>	SPL-318		
<b>Desc.</b>	BDK MOUNT TAB		
<b>Material</b>	4130	<a href="#">Back to Image</a>	
<b>Hole Size A</b>	.255"		
<b>Hole Size B</b>			
<b>Hole Size C</b>			
<b>Base Width</b>	2"		
<b>Thickness</b>	.063"		
<b>Style</b>	flat multi hole		
<b>Comment</b>			

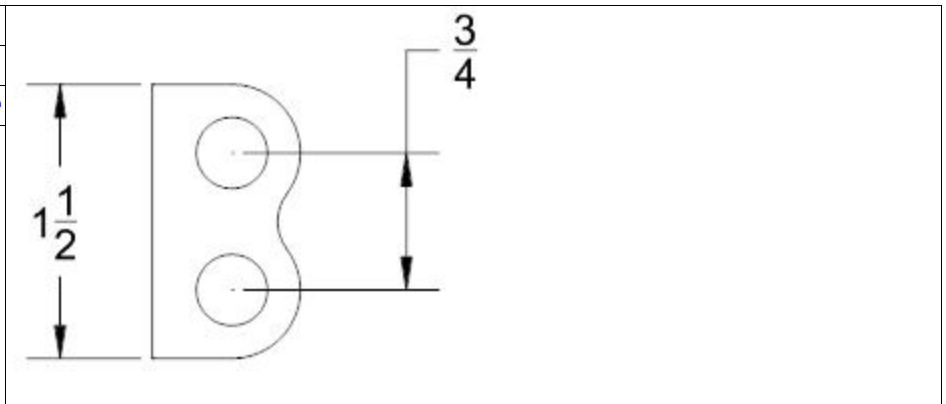
<b>Part #</b>	SPL-268		
<b>Desc.</b>	#3 BULKHEAD TAB		
<b>Material</b>	4130	<a href="#">Back to Image</a>	
<b>Hole Size A</b>	.390"		
<b>Hole Size B</b>			
<b>Hole Size C</b>			
<b>Base Width</b>	N/A		
<b>Thickness</b>	.125"		
<b>Style</b>	flat multi hole		
<b>Comment</b>			

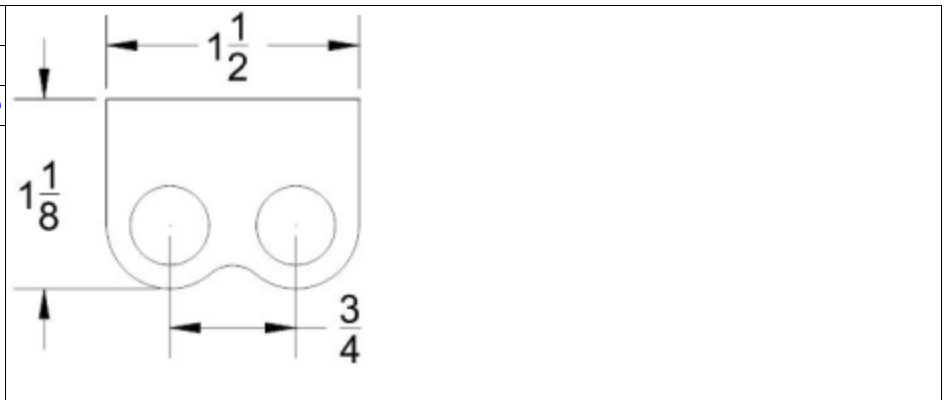
<b>Part #</b>	SPL-257		
<b>Desc.</b>	SWITCH TAB		
<b>Material</b>	4130	<a href="#">Back to Image</a>	
<b>Hole Size A</b>	.46875"		
<b>Hole Size B</b>			
<b>Hole Size C</b>			
<b>Base Width</b>	1 1/2"		
<b>Thickness</b>	.063"		
<b>Style</b>	flat multi hole		
<b>Comment</b>			

<b>Part #</b>	SPL-118	
<b>Desc.</b>	#3 BULKHEAD TAB (2-HOLE)	
<b>Material</b>	4130	<a href="#">Back to Image</a>
<b>Hole Size A</b>	.375"	
<b>Hole Size B</b>		
<b>Hole Size C</b>		
<b>Base Width</b>	1 1/2"	
<b>Thickness</b>	.090"	
<b>Style</b>	flat multi hole	
<b>Comment</b>		

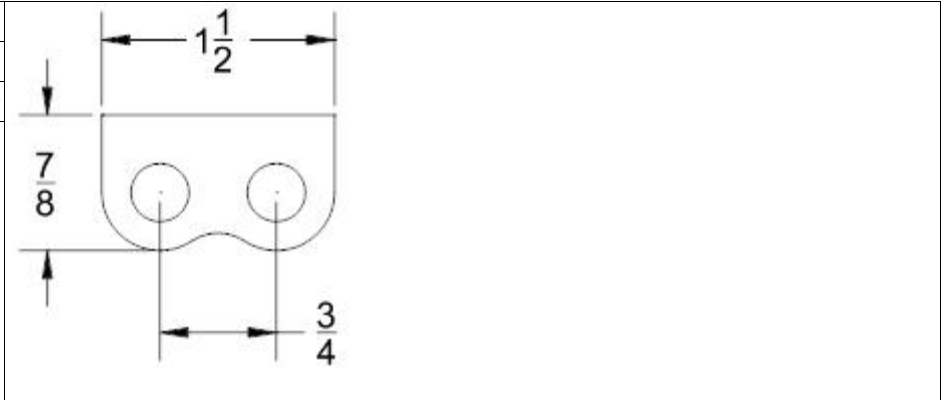

<b>Part #</b>	FC-591	
<b>Desc.</b>	TANK MOUNTING TAB (DOUBLE)	
<b>Material</b>	4130	<a href="#">Back to Image</a>
<b>Hole Size A</b>	.190"	
<b>Hole Size B</b>		
<b>Hole Size C</b>		
<b>Base Width</b>	1 5/8"	
<b>Thickness</b>	.190"	
<b>Style</b>	flat multi hole	
<b>Comment</b>		

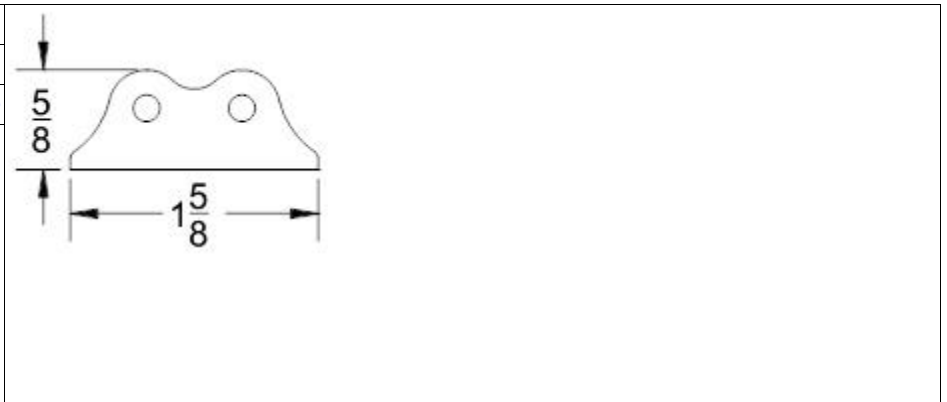

<b>Part #</b>	FC-281-A	
<b>Desc.</b>	STEERING SUPPORT TAB (UPPER)	
<b>Material</b>	4130	<a href="#">Back to Image</a>
<b>Hole Size A</b>	.250"	
<b>Hole Size B</b>		
<b>Hole Size C</b>		
<b>Base Width</b>	N/A	
<b>Thickness</b>	.125"	
<b>Style</b>	flat multi hole	
<b>Comment</b>		

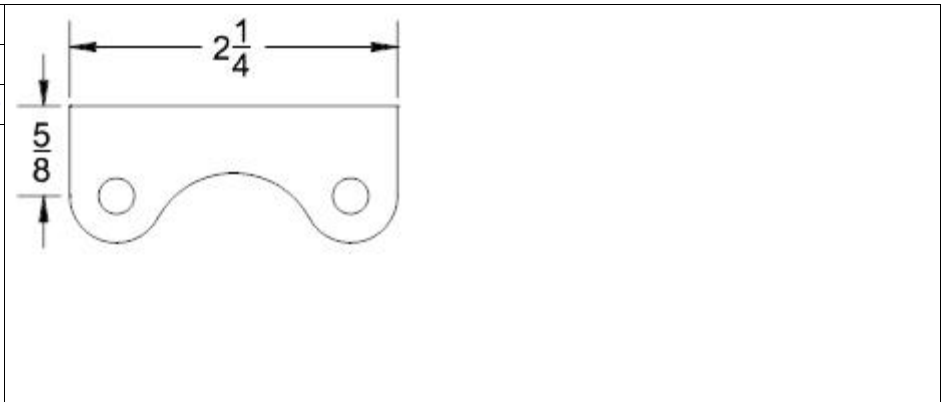

<b>Part #</b>	FC-281	
<b>Desc.</b>	STEERING SUPPORT TAB (UPPER)	
<b>Material</b>	4130	<a href="#">Back to Image</a>
<b>Hole Size A</b>	.250"	
<b>Hole Size B</b>		
<b>Hole Size C</b>		
<b>Base Width</b>	N/A	
<b>Thickness</b>	.125"	
<b>Style</b>	flat multi hole	
<b>Comment</b>		

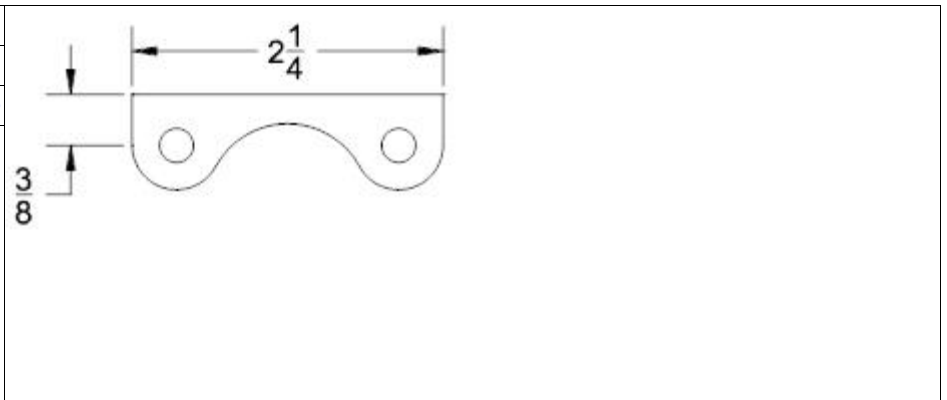

<b>Part #</b>	M-79
<b>Desc.</b>	FIRE BOTTLE MOUNT TAB (FLAT)
<b>Material</b>	4130 <a href="#">Back to Image</a>
<b>Hole Size A</b>	.192"
<b>Hole Size B</b>	
<b>Hole Size C</b>	
<b>Base Width</b>	1 1/2"
<b>Thickness</b>	.125"
<b>Style</b>	flat multi hole
<b>Comment</b>	

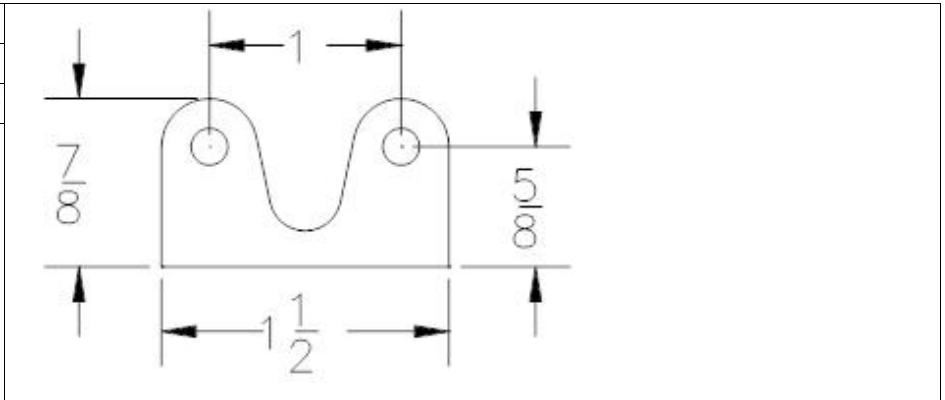

<b>Part #</b>	M-189
<b>Desc.</b>	RUB BLOCK TAB
<b>Material</b>	4130 <a href="#">Back to Image</a>
<b>Hole Size A</b>	.260"
<b>Hole Size B</b>	
<b>Hole Size C</b>	
<b>Base Width</b>	2 3/4"
<b>Thickness</b>	.125"
<b>Style</b>	flat multi hole
<b>Comment</b>	

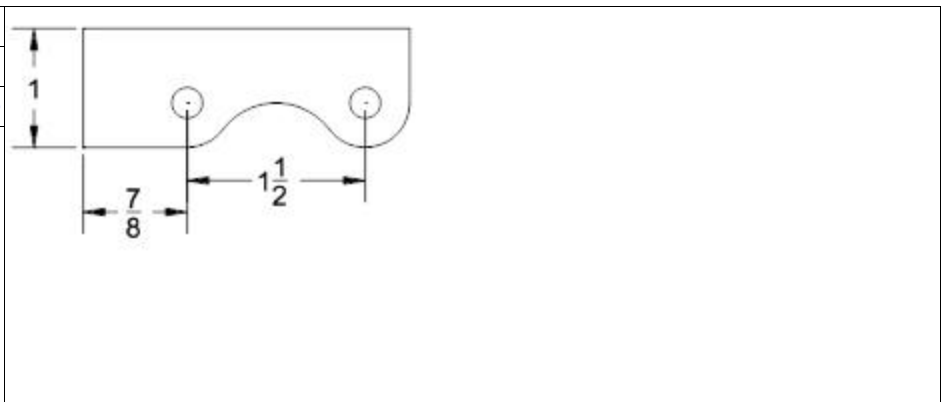

<b>Part #</b>	M-188
<b>Desc.</b>	RUB BLOCK TAB
<b>Material</b>	4130 <a href="#">Back to Image</a>
<b>Hole Size A</b>	.313"
<b>Hole Size B</b>	
<b>Hole Size C</b>	
<b>Base Width</b>	2.700"
<b>Thickness</b>	.125"
<b>Style</b>	flat multi hole
<b>Comment</b>	

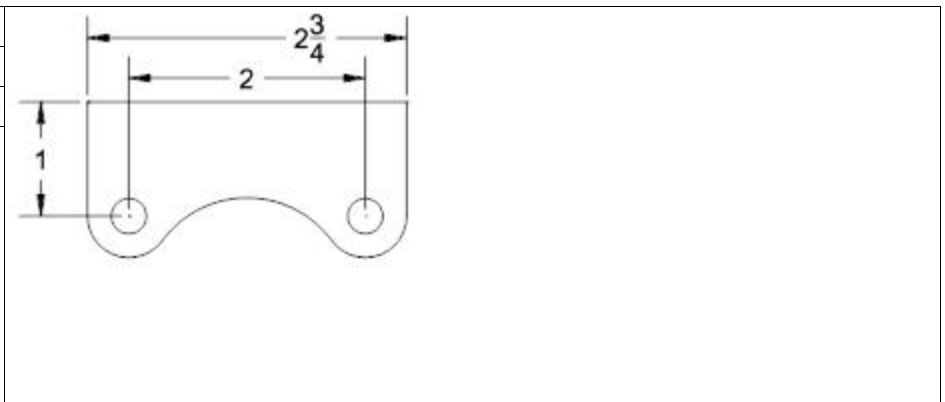

<b>Part #</b>	M-187-A
<b>Desc.</b>	WEIGHT BAR TAB (REAR CHASSIS)
<b>Material</b>	4130 <a href="#">Back to Image</a>
<b>Hole Size A</b>	.313"
<b>Hole Size B</b>	
<b>Hole Size C</b>	
<b>Base Width</b>	
<b>Thickness</b>	.125"
<b>Style</b>	flat multi hole
<b>Comment</b>	

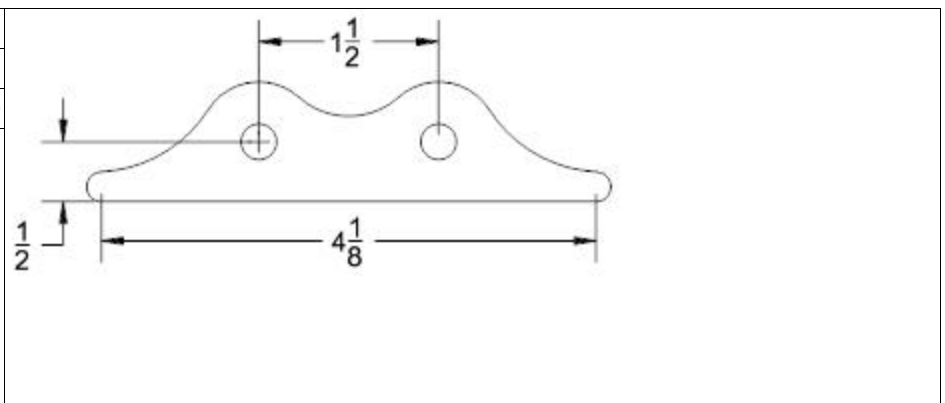

<b>Part #</b>	M-121-I	
<b>Desc.</b>	BILLET PEDAL BASE TAB	
<b>Material</b>	4130	<a href="#">Back to Image</a>
<b>Hole Size A</b>	.250"	
<b>Hole Size B</b>		
<b>Hole Size C</b>		
<b>Base Width</b>	2 3/8"	
<b>Thickness</b>	.090"	
<b>Style</b>	flat multi hole	
<b>Comment</b>		

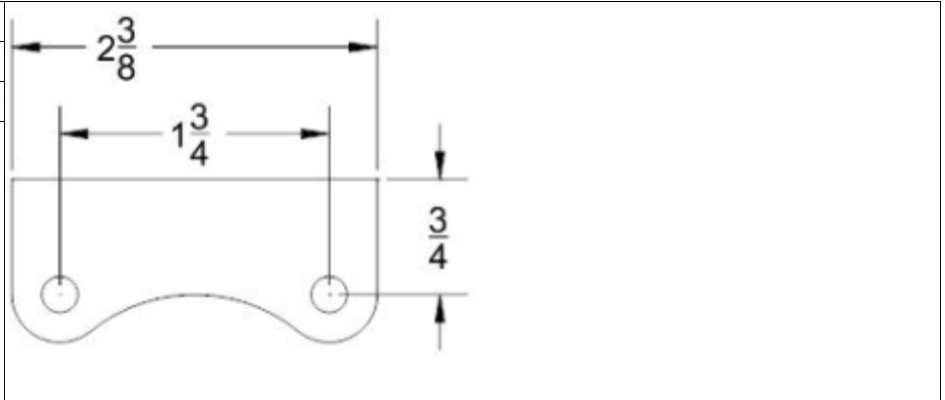

<b>Part #</b>	FC-509-AT	
<b>Desc.</b>	INJECTOR THROTTLE BASE TAB	
<b>Material</b>	6-4 Ti	<a href="#">Back to Image</a>
<b>Hole Size A</b>	.250"	
<b>Hole Size B</b>		
<b>Hole Size C</b>		
<b>Base Width</b>	N/A	
<b>Thickness</b>	.125"	
<b>Style</b>	flat multi hole	
<b>Comment</b>		

